

Without written authorization from Zhongshan Yueguang Intelligent Imaging Technology Co., Ltd., any form of complete or partial replication of this manual is strictly prohibited (except for simple quotations for article or comment evaluation purposes).

November 2023



## Smart Camera Box Canon version

Dedicated section for Canon cameras



Zhongshan Yueguang Intelligent Imaging Technology Co., Ltd.,  
Address: Room 306, C area, 3rd floor, Building 7, Zhangqi Technology  
Incubator, No.70 Zhongshan Gang Road, Torch Hi-tech Industrial Development  
Zone, Zhongshan City.  
Official Address: No.10 Yiwei Road, Torch Hi-tech Industrial Development  
Zone, Zhongshan City, Guangdong Province  
Post code: 528437  
Phone No.: 0086-0760-89878172  
Website: <http://www.ueleret.com.cn>  
© 2023 Ueleret Smart Image Technology Co.,Ltd.

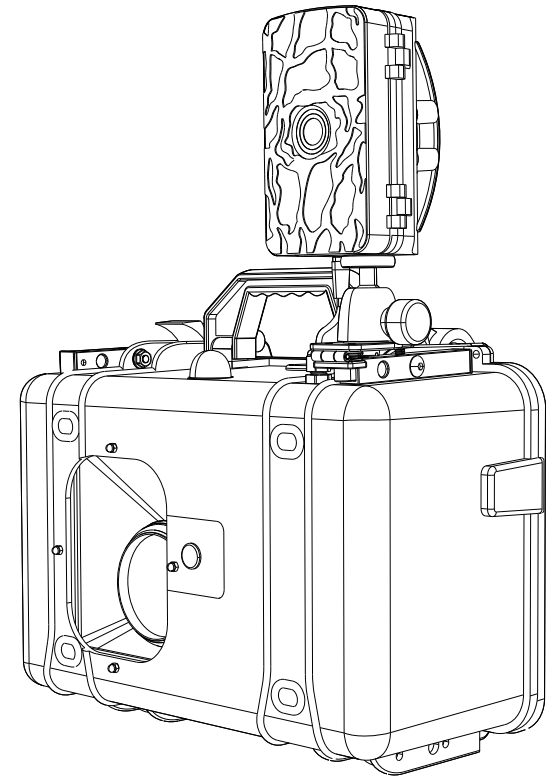

## Content

### Chapter 1 The setting of Canon digital camera

1. Compatible models of Canon camera.....	1
2. Instructions and schematic diagram of Canon model data cable.....	1
3. Battery converter list of Canon main models.....	1
4. DSLR camera setting requirements.....	2
5. Button setting of digital camera video recording.....	2
6. Power saving settings and wake-up time after standby of digital camera..	3
7. Standby time and continuous shooting time of digital camera.....	5
8. Focus setting of digital camera lens.....	6
9. Requirements of Memory card.....	7
10. Special Instructions for R5C camera use.....	7

### Chapter 2 Shooting function and Use Requirements of the Smart camera box 8

### Chapter 3 Shooting function Settings of the Smart camera box 9

1. Connection method of the Logic box .....	10
2. How to use Logic box .....	10
3. Logic box Interface Introduction .....	10

## Chapter 1 The setting of Canon digital camera

### 1. Compatible models of Canon camera



#### DSLR Cameras:

1D X Mark III, 1D X Mark II, 5D Mark IV, 5D Mark III, 6D, 6D Mark II, 7D, 7D Mark II, 90D, 80D, 800D, 200DII

#### Mirrorless Cameras:

R3, R5, R5 C, R6, R6 Mark II, R7, R8, R10

### 2. Canon model shutter release cable instructions and schematic diagram

Camera Model	Shutter release cable
R3, R5, R5 C 1D X Mark III, 1 D X Mark II, 5 D Mark III, 5D Mark IV 6 D, 6 D Mark II, 7 D, 7D Mark II	 3.5mm-C2
R6, R6 Mark II, R7, R8, R10 90D, 80D, 800D, 200D II	 3.5mm-C1

### 3. Battery converter list of Canon main models

Camera Model	The battery converter models
R3, 1D X Mark III, 1D X Mark II	U/DR-E19
5D Mark IV 5 DMark III, 6 D, 6 D Mark II 7D, 7 D Mark II, 90D, 80D	U/DR-E6
R5, R5 C, R6, R6 Mark II, R7	
R8, R10, 800D, 200D II	U/LP-E17

Using the digital camera's own battery may not ensure a long-term power supply.

Using the Smart camera box power supply can meet the endurance requirements.

The digital camera battery converter standard with a U/DR-E6, and other models are available for purchase.

The user can choose the appropriate camera battery converter according to your digital camera model.

### 4. DSLR camera setting requirements

Canon DSLR camera settings requirements for AF-ON function: The camera's focus function cannot be set to the AF-ON button. Settings as follow:

For 1DX Mark III and 1DX Mark II cameras:

Step 1: Press [MENU] to enter the page six of Custom Function area. Click the Custom Control button.

Step 2: Select the Half-press Shutter button metering and AF start.

Step 3: Select the "Metering and AF start" option and press the SET button to confirm the settings.

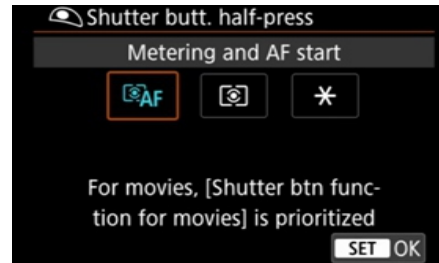
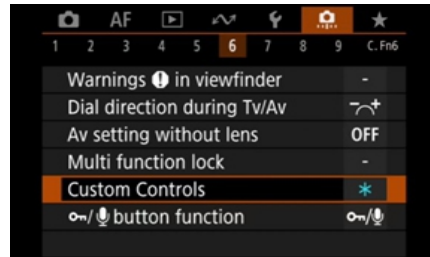

### 5. Button setting of digital camera video recording

To switch from the video button mode to the shutter button mode for video recording on the digital camera, please follow the steps below.

Here we take the mirrorless camera R5 as an example. (Set in video mode of digital camera)

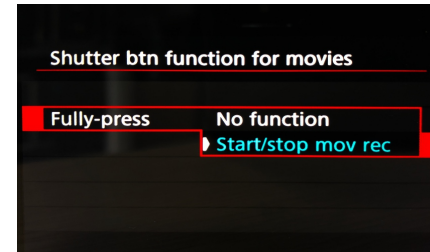
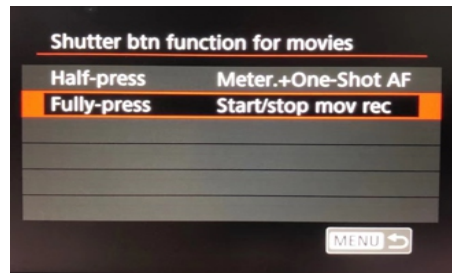
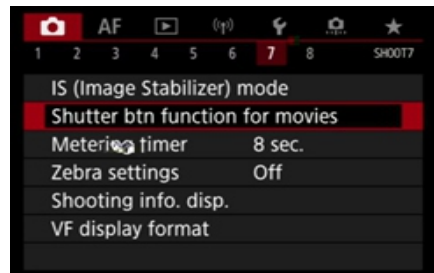

Example of setting up DSLR camera with EOS 5D Mark IV. (Set in video mode of digital camera)

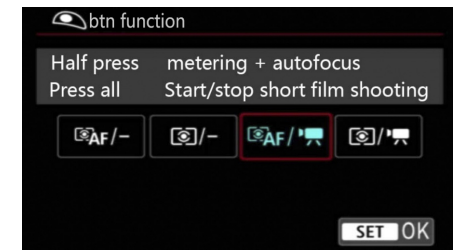
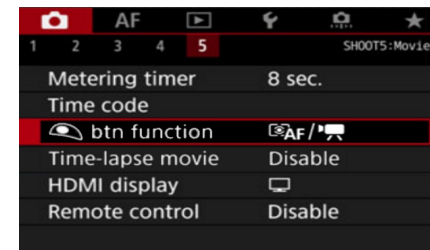

### 6. Power saving settings and wake-up time after standby of digital camera

(1) The digital camera can be set to either turn off or do not turn off the auto-sleep mode.

- a. The above two settings have a significant impact on the digital camera's power consumption, which directly affects the outdoor using time of the Smart Camera Box.
- b. The above two settings have different response times for the Smart Camera Box to control the digital camera to start shooting after being triggered by the trail camera. When the digital camera is in sleep mode, it takes some time for the Smart Camera Box to wake up the digital camera and shoot.

Canon camera sleep mode and wake-up time table				
Camera status	Wake-up time for mirrorless cameras		Wake-up time for DSLR cameras	
	Shooting mode	Recording mode	Shooting mode	Recording mode
Hibernate status	0.5S	1S	0.5S	2S
Dis-hibernate status	0	0	0	0

The user can decide whether to turn off or keep the sleep mode function of the digital camera according to the shooting situation.

(2) Setting method for mirrorless camera using EOS R5 as an example

a. In the menu, set "Auto power off" to "Off" so that the camera will not enter hibernate mode. Choosing other times will cause the camera to enter hibernate mode.

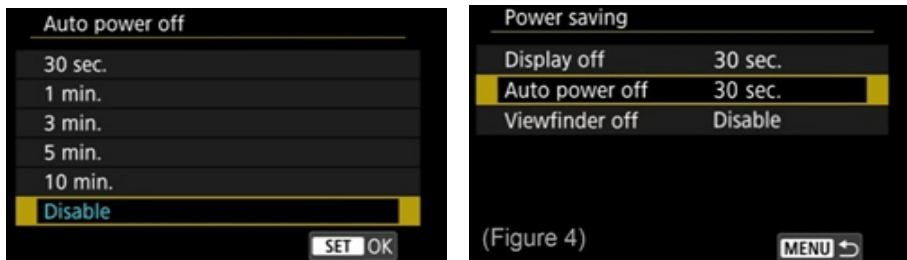

Also, turning off the display and viewfinder will reduce power consumption of the camera. (refer to Figure 4)

Setting method for DSLR taking EOS 5D Mark IV as an example

b. In the menu, set "Auto power off" to "Off" so that the digital camera will not enter hibernation mode. Choosing other times will cause the camera to enter hibernation mode.

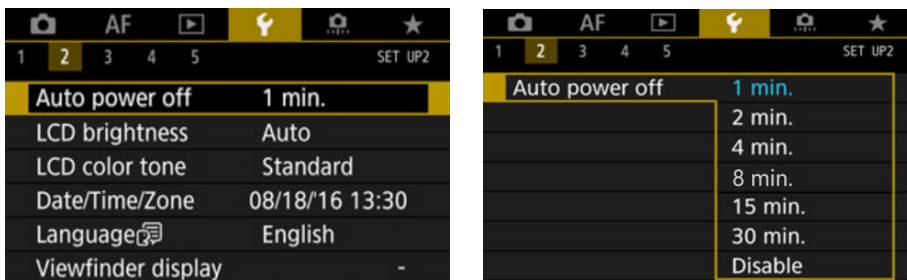

c. Image review setting : set to turn off

Figure 1: The image review setting has two options: off and display time

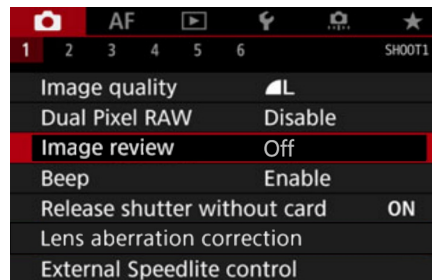
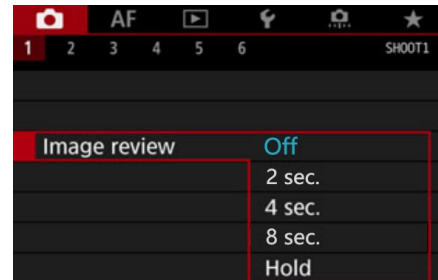

Figure 2: It is recommended to set it to off



d. After finishing the adjustment of the digital camera, please close the LCD screen to turn off the display.

7. Digital camera standby time and continuous shooting time

The duration of outdoor shooting with the Smart Camera Box and digital camera directly affects the user to capture the desired targets.

The power consumption differs greatly between setting the digital camera to auto-hibernation or off-hibernate, as well as setting the LCD display to auto-off or not (always display the shooting screen).

The following table shows the calculation of digital camera standby time and continuous shooting time based on power consumption.

Camera Status	Camera Model	Mirrorless EOS R5		
	Battery Model	UB-01 372Wh	UB-04 82.88Wh	UB-04 93Wh
	Time Unit	Hour(s)		
Hibernate status	Camera body automatically hibernate	885	201	226
Video Mode	Continuous recording (HD) without interruption	42	10	11

Notes: (1) The standby time of the digital camera is consistent with the usage time of the Smart camera box.

(2) Taking a representative models as examples, tested under indoor conditions and at a room temperature of 25 C the data may vary depending on different usage environments and conditions.

(3) The power consumption of different camera models varies slightly. Generally, higher-end models tend to consume more power.

(4) With the light sensing system, the number of standby days is calculated as 12 hours a day.

(5) When using the 93WH battery, it is not recommended to use it with EOS 1DX series cameras or R5C cameras. Testing has shown that the battery depletes rapidly and has a short usage time.

## 8. Digital camera lens focus setting

The Digital camera lens set to AF auto focus mode and MF manual focus mode., there may be slight differences in response speed. The camera lens for some camera models is set to AF mode, there may be a long response time or even inability to take pictures.

Camera Type	Model	Auto focus Setting for Lens	
		AF	MF
Mirrorless Camera	R3/R5/R5 C/R6/R6 Mark II/R7/R8/R10	Available	Available
DSLR Camera	1D X Mark III, 1D X Mark II	Available	Available
	5D Mark IV, 5D Mark III, 6D, 6D Mark II, 7D, 7D Mark II, 90D, 80D, 800D, 200D II	Unavailable	Available

Notes: Most digital camera lenses have an AF/MF switch lever. Many newly released lenses do not have an AF and MF switch lever, and the lens focusing mode can be set in the camera body menu.

The setting method takes EOS R5 as an example:

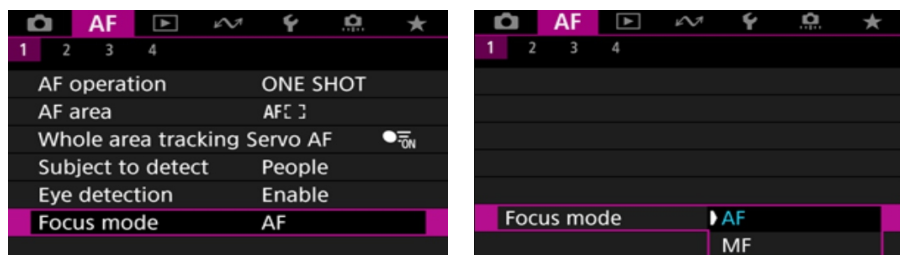

## 9. Memory card requirements

1. In shooting mode, the number of continuous shots will be affected during continuous shooting of the writing speed of the memory card is relatively low. You can continue to shoot until the camera has written all the pre-stored shots to the memory card.

2. In video recording mode, It will affect that the camera cannot shoot video normally according to the shooting function if the writing speed of the memory card is relatively low. A memory card with an appropriate writing speed is required.

3. Cameras that released too early are recommended to be used only for taking photos, not for videos. You must use a memory card with a fast writing speed for video recording.

4. The video cannot be taken due to the memory card, which results in that when the trail camera detects animals, the smart camera box cannot command the camera to start video recording.

(1). For cameras with high pixels, the memory card cannot meet the shooting requirements when the video file has high pixels.

(2). When the SD card inserted into slot 2, most cameras have specific file format and bitrate (Mbps) requirements. If the bitrate (Mbps) exceeds the specified requirements, it may result in the inability to capture video. For detailed information, please refer to the user manual of the camera model you are using.

## 10. Special Instructions for R5C camera use

1. The R5C camera has separate systems for photos and videos and does not have a dedicated "video recording button" function. When both the camera and the control box are in video mode, the smart camera box can command the R5C to start video recording upon detecting.

2. When using an SD card in slot 2, if the bitrate exceeds 650Mbps, it will not be functional. This will manifest as the trail camera detecting animals, but the smart camera box will be unable to command the R5C camera to start video recording.

3. In video recording mode, the R5C camera does not have a hibernate function and consumes more power. For standby time and continuous shooting time, please refer to the table below:

Camera status	Camera Model	Mirrorless camera EOS R5 C	
	Battery Model	UB-01 372Wh	UB-04 82.88Wh
	Time Unit	Hour(s)	
Hibernate status	The camera body automatically hibernates	815	170
Video Mode	Continuous Recording (HD)	28	5

## Chapter 2 Shooting function and use Requirements of the Smart camera box

### 1. The Smart camera box uses a fixed shooting function.

The shooting function of the Smart camera box is fixed to the control system and cannot be adjusted. With a dial switch, the switch is set to single shooting, continuous shooting, or video recording, and execute the corresponding shooting function.

(1) At single shooting, the digital camera shooting mode must be set to single shot.

Number of continuous single shots: 5

Continuous shooting interval time: 1 s

(2) At continuous shooting, the digital camera shooting mode must be set to continuous shooting, and the type of continuous shooting is not limited.

Every continuous shooting time: 2 s

Continuous shooting interval time: 1 s

Continuous shooting times: 3 time(s)

(3) At video recording, the digital camera shooting mode must be set to video recording.

Every recording time: 28 s

Interval time between sessions: 1 s

Recording times: 1 time(s)

3. The dial switch is set to the video shooting mode initially. With an external shooting function setting box Logic box, the shooting function can be set or modified when using the Smart camera box. Please refer to Chapter 3 for details.

### 2. Requirements for turning off the hibernation setting of the digital camera when using the Smart camera box.

The use of the Smart camera box without the external shooting function setting box Logic box, have the following requirements:

(1) Setting the digital camera lens to AF/MF focusing mode, as outlined in Chapter 1, Article 8.

(2) The digital camera's power-saving settings should be used as required to ensure effective shooting.

See the table below for details

Digital Camera Power Saving Settings and Lens Focusing Settings				Mirrorless Camera Models	DSLR Camera Models
The camera will not enter hibernate mode when the auto-hibernate mode is turned off.	Shooting mode	Single shooting	AF mode	Compatible camera models	All compatible camera models
			MF mode	Compatible camera models	
	Continuous shooting	AF mode	Compatible camera models	All compatible camera models	
		MF mode	Compatible camera models		
Recording mode		AF mode	Compatible camera models	All compatible camera models	1DXII/1DXIII
			Incompatible camera models		5D Mark III/5D Mark IV/6D/6D Mark II 7D/7D Mark II/80D/90D/800D/200D II
Recording mode		MF mode	Compatible camera models	All compatible camera models	All compatible camera models
	The camera will automatically enter hibernate mode and power off when set to auto-hibernate mode.	Shooting mode	Single shooting	AF mode	Compatible camera models
			MF mode	Compatible camera models	
Continuous shooting		AF mode	Compatible camera models	All compatible camera models	
		MF mode	Compatible camera models		
Recording mode		AF mode	Compatible camera models	All compatible camera models	-
		MF mode	Compatible camera models	All compatible camera models	All compatible camera models

Notes:

\*\* , All compatible DSLR models support single shot mode, but the number of shots taken may be less than the number set in the shooting logic. For example, if 5 shots are set to be taken, only 3 or 4 shots may be taken.

This table also includes the AF/MF focus mode settings, so user can have a clear understanding of the usage requirements.

## Chapter 3 Shooting function Settings of the Smart camera box

New shooting functions can be set and modified with the Smart camera box connected to the external shooting function setting box (Logic box).

(1)The digital camera's power-saving setting can be set to either off-hibernate mode or hibernate mode to significantly extend standby time.

(2)The digital camera's power on/off time can be set by adjusting the new shooting functions when connected to the shooting functions setting box (Logic box).

### 1. Connection method of the Logic box

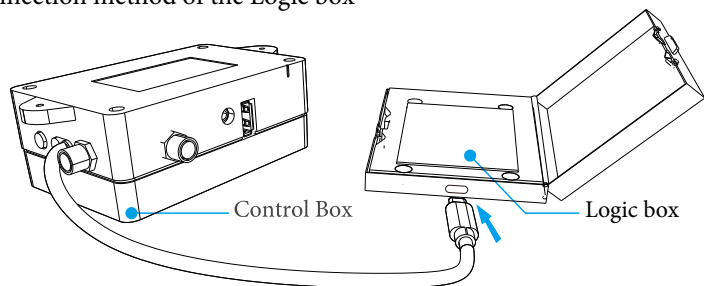

It would work that insert the connection cable into the data interface of Logic box.

### 2. How to use Logic box

Logic box user manual

1. Upon initial connection to the Logic box, the display shows the default logic for all shooting modes( single shooting, continuous shooting, or video mode).
2. Logic box can only modify one shooting mode (single shooting, continuous shooting, or video) at one time. Once the shooting mode is changed (by toggling the switch), any previously modified logic reverts to the default shooting logic.
3. Modified logic is retained in memory after adjustment. As long as the shooting mode remains unchanged, the modified logic remains effective. If the Logic box is removed or plugged in, the screen display returns to the default logic interface on the Logic box, but the modified logic remains active until new settings are applied.
4. The same principle applies to modifying interval times and shot counts.

Example: Modified logic set as 5 shots single shooting, 3s continuous shooting, and 35s video.

Control box mode		Default logic	After logic modification, the shooting mode remains unchanged (toggle switch unchanged)				After logic modification, as long as the shooting mode is changed (by toggling the switch), the logic reverts to the default shooting logic.
			The Logic box remains connected to the Smart camera box, and the Smart camera box remains powered on.		If the Logic box is removed or plugged in, and the Smart camera box's power turned on or off.		
Shooting mode	Number of shots/ Video time	Logic box display	Actual shooting logic	Logic box display	Actual shooting logic	Logic box display/ Actual shooting logic	
Single shooting	3 shots	5 shots	5 shots	3 shots	5 shots	3 shots	
Continuous shooting	2s	3s	3s	2s	3s	2s	
Video	28s	35s	35s	28s	35s	28s	

### 3. Logic box Interface Introduction

Page 1: Cover - Smart camera box Canon version

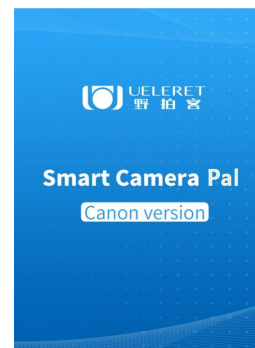

Page 2:

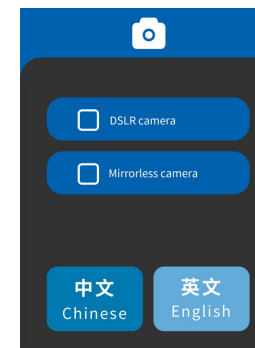

Enter the "Logic box" page, first select the type of camera: DSLR or mirrorless camera. Depending on whether the digital camera can go into hibernation mode or if the LCD screen turns off, the functions of shooting will differ for DSLRs and mirrorless cameras. Once selected, the Smart camera box will provide corresponding shooting instructions to meet the digital camera's different settings. Failure to follow these instructions may result in disorderly shots or failed shooting attempts.

Page 3:

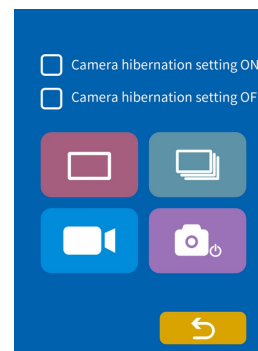

The option "Enable Camera Hibernation" refers to the digital camera being set to hibernate. When the shooting ends after a certain amount of time, the digital camera's power-saving function will put the digital camera into hibernation mode.

The option "Disable Camera Hibernate" refers to the digital camera turned off the power-saving function, and the digital camera will not enter hibernation mode.

 Set your digital camera to single shooting mode and click to enter the shooting function settings page for single shooting mode.

 Set your digital camera to continuous shooting mode and click to enter the shooting function settings page for continuous shooting mode.

 Set your digital camera to recording mode and click to enter the shooting function settings page for recording mode.

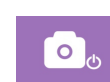
 Click to enter the digital camera shutdown and startup time settings page.

Page 4: Shooting function settings for single shooting mode.  
Click on the blue box to pop up the number selection options.

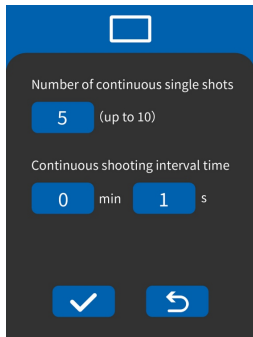

After confirming the settings, if the settings are successful, the OK page will pop up. If the settings are not successful, the NO page will pop up. The same process applies for subsequent pages.

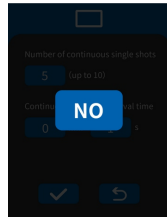
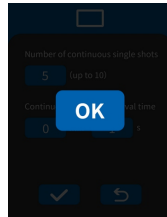

Page 5: Click on the blue box to enter the number selection options for shooting function settings for continuous shooting mode.

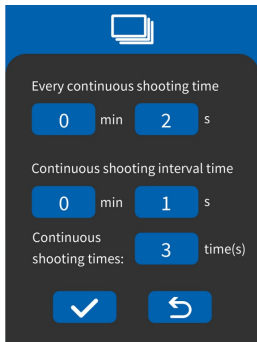

Page 6: Click on the blue box to enter the number selection options for shooting function settings for recording mode.

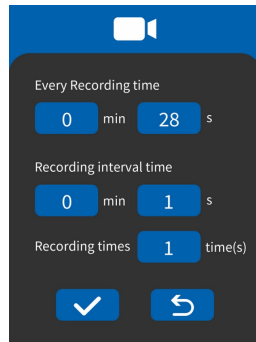

Page 7: Digital camera shutdown options

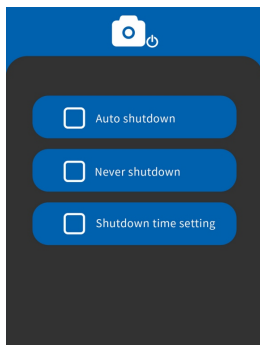

Note of Page 7

(1). Digital camera [Power Off] is different from [Hibernation]. Turning off the digital camera means that the Smart camera box stops supplying power to the digital camera, and the digital camera stops working completely. The digital camera into hibernation mode means that the power saving function of the digital camera itself makes the digital camera enter the hibernation mode, while the Smart camera box continues to supply power to the digital camera.

(2).Option "Auto shutdown"

When this option is selected, the Smart camera box will automatically stop supplying power to the digital camera and put it into a shutdown state when day and night change, the light sensor detects that ambient light intensity is insufficient for the digital camera to take pictures. The Smart camera box is in the lowest power consumption state in this mode. When the light intensity reaches the required level for photography, the Smart camera box automatically supplies power to the digital camera, and the digital camera enters the power-on state.

(3). Option "Never shutdown"

When this option is selected, the Smart camera box will continuously supply power to the digital camera, even if the light sensor detects that the ambient light intensity changes, the Smart camera box will not issue an instruction to stop powering the digital camera, and the digital camera will be in continuous working mode. This option is generally used when the user has connected a flash or lighting equipment, and the digital camera needs to take pictures at night.

(4). Option "Shutdown time setting"

If the user does not want to use the ambient light sensor to automatically turn off the digital camera based on the brightness of the surroundings, thinks that the shooting conditions require a customized power-off or power-on time, then can select this option, and enter the page 8 to manually set the power off time and duration.

Page 8: Enter the "Setting the shutdown time"

User can set how long will the digital camera take to shut down and the duration for which it will remain off. As there is no clock on the camera, it is not possible to set the power off time based on local time (such as Beijing time or London time). Instead, the power off time is set based on the working duration time.

Click on the blue box to pop up the number selection options. After confirming the settings, if the settings are successful, the OK page will pop up. If the settings are not successful, the NO page will pop up.

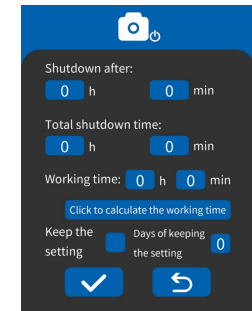

**Disclaimer:** As this product is an original patented product, there may be changes in its features or specifications in the future. In the event of any changes, please refer to the official website of our company. Yueguang Intelligent reserves the right to interpret any changes.